

## QUICK TRAINING GUIDE: MO-1

### 1 Configure your classroom

#### Basic Configuration

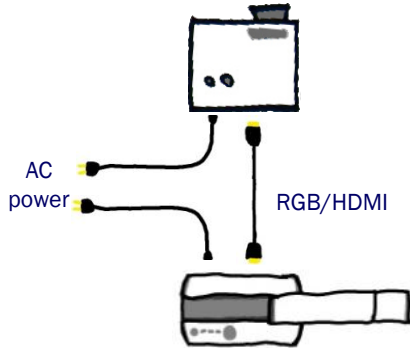

#### With Computer

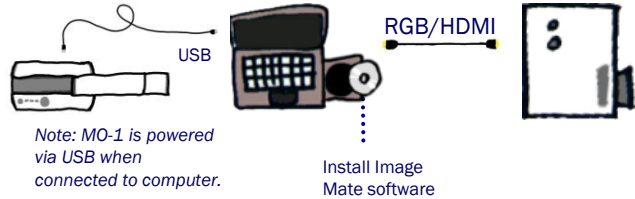

#### Rear panel

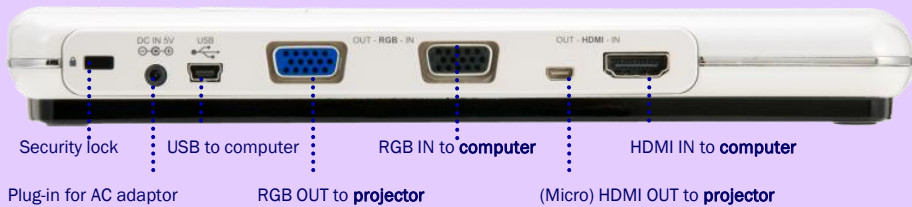

### 2 Power on the MO-1, Zoom and Focus

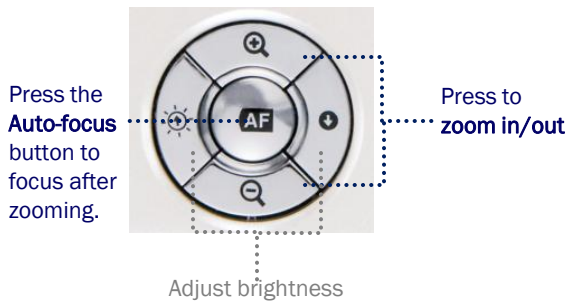

### 3 Rotate

Rotate the camera arm close to a small object, turn the camera head horizontally to view students giving a presentation, speech, etc.

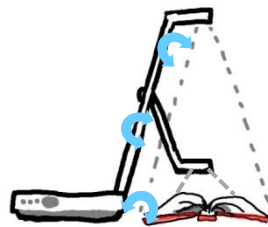

Rotate the camera head to when using MO-1 as web cam.

## 4 Capture and Review

Press to view image from HDMI/RGB/USB or view computer desktop

### A. Insert SD card

Capture the image of worksheets, student work, etc. and save them on the SD card. Quickly and easily review later during class by pressing the SD button.

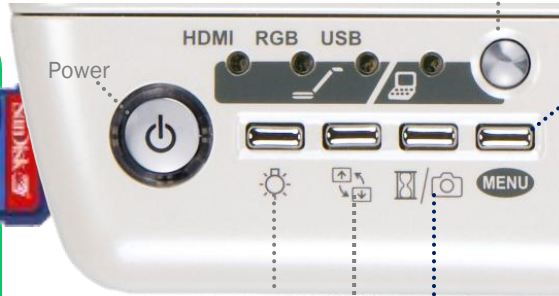

### C. Review saved images

Press Menu then use the [ ]·[ ]·[ ]·[ ] and AF buttons to highlight and select the SD card icon. You can now view and select any saved image.

### B. Capture image

Hold down for longer than 1 second to capture image. To pause the image, hold down for less than 1 second. Push again to unfreeze the image.

## 5 Install Image Mate software

Install Image Mate software (ensure MO-1 is disconnected during installation). Connect the MO-1 to the computer and open Image Mate. You will now be able to **annotate on the live image, save images and videos to the computer, record time-lapse photography** (set interval time in Settings before beginning time-lapse).

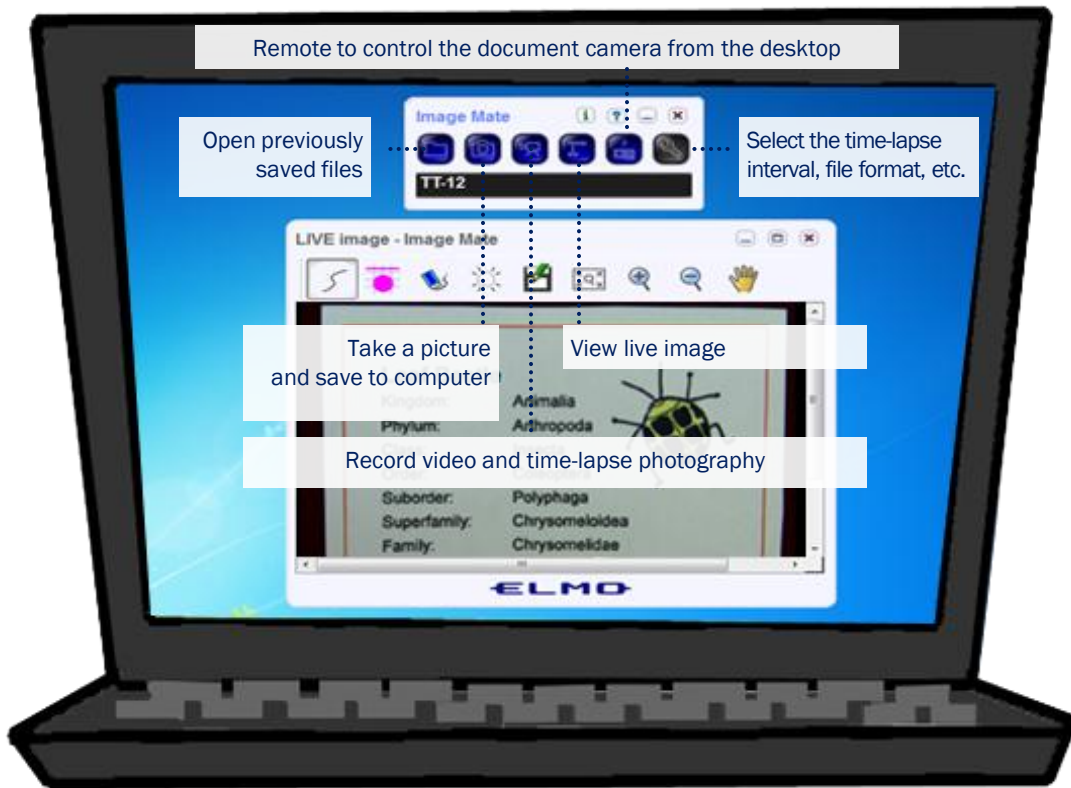

Download Image Mate at <http://www.elmoua.com/support/101>